

### SPECIFICATIONS

#### PRODUCT SPECIFICATIONS

Stainless Steel 25" x 22" x 6-1/2" Single Bowl Drop-in ADA Sink. Sink is manufactured from 18 gauge 304 Stainless Steel with a Lustrous Satin finish, Rear Center drain placement, and Bottom only pads.

|                              |                            |
|------------------------------|----------------------------|
| <b>Installation Type:</b>    | Drop-in                    |
| <b>Material:</b>             | 304 Stainless Steel        |
| <b>Finish:</b>               | Lustrous Satin             |
| <b>Gauge:</b>                | 18                         |
| <b>Sound Deadening:</b>      | Bottom only pads           |
| <b>Number of Bowls:</b>      | 1                          |
| <b>Sink Dimensions:</b>      | 25" x 22" x 6-1/2"         |
| <b>Bowl 1 Dimensions:</b>    | 21" x 15-3/4" x 6-1/8"     |
| <b>Drain Size:</b>           | 3-1/2" (89mm)              |
| <b>Drain Location:</b>       | Rear Center                |
| <b>Minimum Cabinet Size:</b> | 30"                        |
| <b>Mounting Hardware:</b>    | Included                   |
| <b>Cutout Template #:</b>    | <a href="#">1000001188</a> |

Template is available for download at [justmfg.com](http://justmfg.com). CAD software will be required to open the template.

#### Cutout Dimensions for Drop-in Installation:

24-3/8" x 21-3/8" (619mm x 543mm) with 1-1/2" (38mm) corner radius

#### Hole Drilling Configurations:

1-1/2" (38mm) Diameter Faucet Holes on 4" (102mm) Centers



Quality Grade Plumbing Products.

Since 1933 we have become the industry standard for designing and producing quality grade plumbing products and fixtures. Our role as an industry leader remains unsurpassed.



#### Product Compliance:

ASME A112.19.3/CSA B45.4  
ADA & ICC A117.1



Sinks are listed by IAPMO® as meeting the applicable requirements of the Uniform Plumbing Code®, International Plumbing Code®, and National Plumbing Code of Canada.



Complies with ADA & ICC A117.1 accessibility requirements when installed according to the requirements outlined in these standards.

[Clean and Care Manual \(PDF\)](#)

[Installation Instructions \(PDF\) - 200000856](#)

[Warranty \(PDF\)](#)

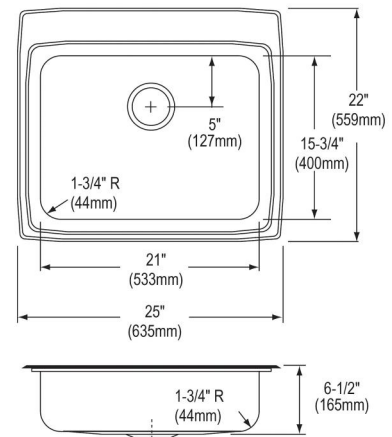

PART: \_\_\_\_\_ QTY: \_\_\_\_\_

PROJECT: \_\_\_\_\_

CONTACT: \_\_\_\_\_

DATE: \_\_\_\_\_

NOTES: \_\_\_\_\_

APPROVAL: \_\_\_\_\_

In keeping with our policy of continuing product improvement, Just Mfg reserves the right to change product specifications without notice. Please visit [justmfg.com](http://justmfg.com) for the most current version of Just Mfg product specification sheets. This specification describes a product with design, quality, and functional benefits to the user. When making a comparison of other producers' offerings, be certain these features are not overlooked.

**SPECIFICATIONS**

**Model(s) SLADA2225A65-J**

**Installation Profile:**



*In keeping with our policy of continuing product improvement, Just Mfg reserves the right to change product specifications without notice. Please visit [justmfg.com](http://justmfg.com) for the most current version of Just Mfg product specification sheets. This specification describes a product with design, quality, and functional benefits to the user. When making a comparison of other producers' offerings, be certain these features are not overlooked.*