

**PRODUCT SPECIFICATIONS**

Elkay Wall Mount ADA Cooler, Non-Filtered Non-Refrigerated Stainless. Furnished with Vandal Resistant bubbler. Mechanical Front and Side Bubbler Pushbar activation. Product shall be Wall Mount (On Wall), for Indoor applications, serving 1 station(s). Unit shall be lead-free design which is certified to NSF/ANSI 61 & 372 (lead free) and meets Federal and State low-lead requirements.

<b>Finish:</b>	Stainless Steel
<b>Power:</b>	No Electrical Required
<b>Bubbler Style:</b>	Vandal Resistant
<b>Activation by:</b>	Mechanical Front and Side Bubbler Pushbar
<b>Mounting Type:</b>	Wall Mount (On Wall)
<b>Chilling Capacity:</b>	Non-refrigerated
<b>Dimensions (L x W x H):</b>	18-1/16" x 18-5/8" x 20-5/8"
<b>Approx. Shipping Weight:</b>	36 lbs.
<b>Installation Location:</b>	Indoor
<b>No. of Stations Served:</b>	1

- Mechanically-Activated bubbler continues to supply water in event of service disruptions.



**Included with Product:** Water Cooler  
**Ships in one box.**

AMERICAN PRIDE. A LIFETIME TRADITION. Like your family, the Elkay family has values and traditions that endure. For almost a century, Elkay has been a family-owned and operated company, providing thousands of jobs that support our families and communities.



**PRODUCT COMPLIANCE**

- ADA & ICC A117.1
- ASME A112.19.3/CSA B45.4
- Buy American Act
- NSF/ANSI 61 & 372 (lead free)



Complies with ADA & ICC A117.1 accessibility requirements when installed according to the requirements outlined in these standards. Installation may require additional components and/or construction features to be fully compliant. Consult the local Authority Having Jurisdiction if necessary.

[Installation Instructions \(PDF\)](#)

Water Systems are warranted for 12 months from date of installation. **Warranty pertains to drinking water applications only. Non-drinking water applications are not covered under warranty.**

[Warranty \(PDF\)](#)

PART: \_\_\_\_\_ QTY: \_\_\_\_\_

PROJECT: \_\_\_\_\_





CONTACT: \_\_\_\_\_

DATE: \_\_\_\_\_

NOTES: \_\_\_\_\_

APPROVAL: \_\_\_\_\_

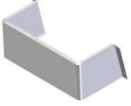
*In keeping with our policy of continuing product improvement, Elkay reserves the right to change product specifications without notice. Please visit elkay.com for the most current version of Elkay product specification sheets. This specification describes an Elkay product with design, quality, and functional benefits to the user. When making a comparison of other producers' offerings, be certain these features are not overlooked.*

Optional Accessories		
<a href="#">EWF172</a>	Elkay WaterSentry VII Filter Kit (Coolers + Fountains) <a href="#">Spec Sheet (PDF)</a>	
<a href="#">MLP100</a>	In-wall Carrier for Single-station On-wall Bottle Fillers, Coolers & Fountains <a href="#">Spec Sheet (PDF)</a>	
<a href="#">98324C</a>	Accessory - Cane Apron for HAC, HVR, EMABF & VRC Models (Stainless) <a href="#">Spec Sheet (PDF)</a>	
<a href="#">RP2130</a>	Accessory - Wall Bezel Black <a href="#">Spec Sheet (PDF)</a>	

*In keeping with our policy of continuing product improvement, Elkay reserves the right to change product specifications without notice. Please visit [elkay.com](http://elkay.com) for the most current version of Elkay product specification sheets. This specification describes an Elkay product with design, quality, and functional benefits to the user. When making a comparison of other producers' offerings, be certain these features are not overlooked.*

RATED FOR INDOOR USE ONLY

Open space rough-in design permits new installation or replacement of existing fountains and coolers with this Elkay cooler when rough-in is within the outline shown.

#### IMPORTANT! INSTALLER PLEASE NOTE:

This water cooler has been designed and built to provide water to the user which has not been altered by materials in the cooler waterways.

The grounding of electrical equipment such as telephone, computers, etc to water lines is a common procedure. This grounding may be in the building or occur away from the building. This grounding can cause electrical feedback into a water cooler creating an electrolysis which creates a metallic taste or causes an increase in the metal content of the water. This condition is avoidable by installing the cooler using the proper materials as shown below.

#### NOTICE

The water cooler must be connected to the water supply using a dielectric coupling. The cooler is furnished with a non-metallic strainer which meets this requirement. The drain trap which is provided by the installer should also be plastic to completely isolate the cooler from the building plumbing system.

#### OPERATION OF QUICK CONNECT FITTINGS

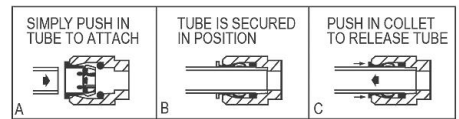

PUSHING TUBE IN BEFORE PULLING IT OUT HELPS TO RELEASE TUBE

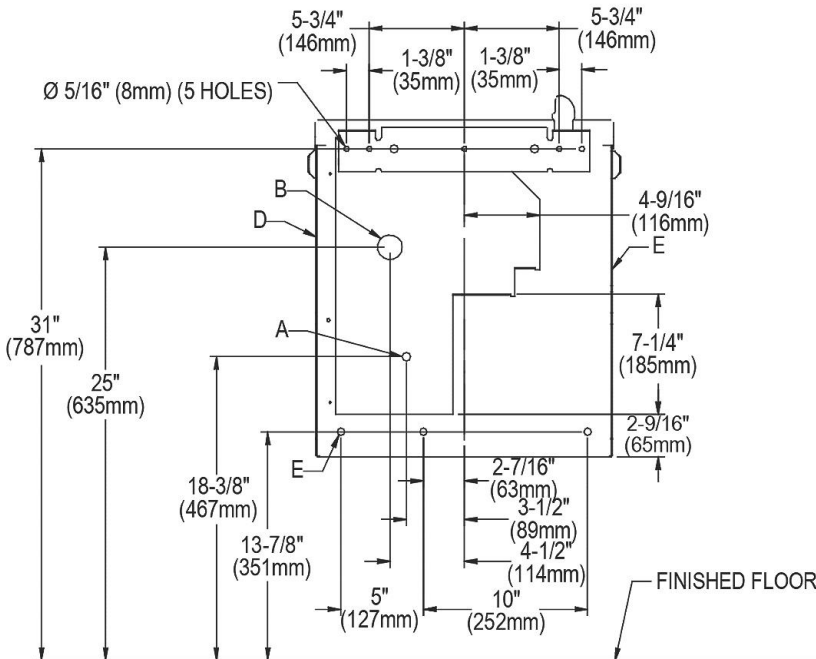
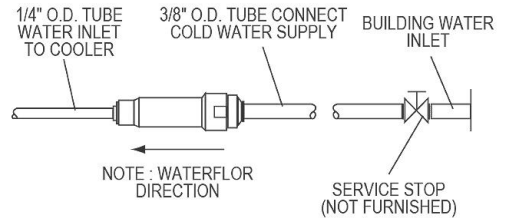

REDUCE HEIGHT BY 3 INCHES FOR INSTALLATION OF CHILDRENS ADA COOLER

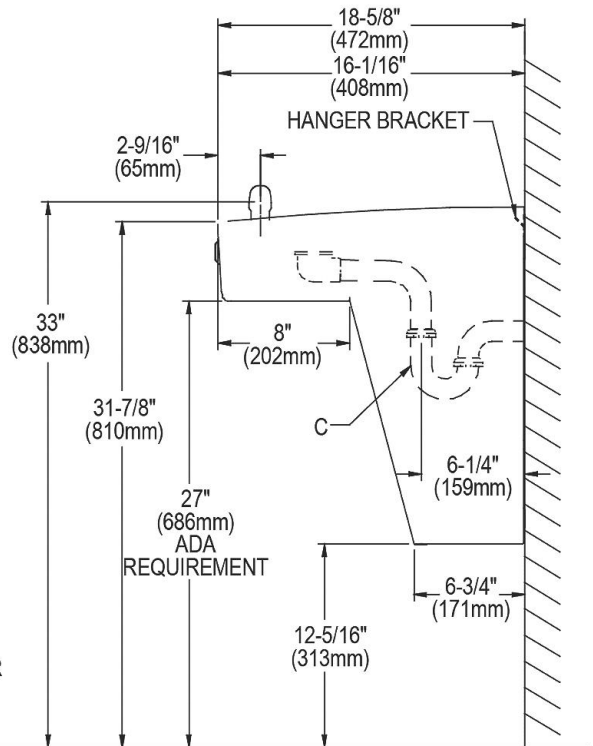

#### LEGEND

- A = Recommended water supply location. Shut off valve (not furnished) to accept 3/8" O.D. unplated copper tube connect. Up to 3" (76mm) maximum out from wall.
- B = Recommended waste outlet location. To accommodate 1-1/4" nominal drain. Drain stub 2" (51mm) out form wall.
- C = 1-1/4" Trap (not furnished).
- D = Insure proper ventilation by maintaining 6" (152mm) (min.) clearance from cabinet louvers to wall.
- E = 7/16" (11mm) Bolt holes for fastening to wall.

In keeping with our policy of continuing product improvement, Elkay reserves the right to change product specifications without notice. Please visit [elkay.com](http://elkay.com) for the most current version of Elkay product specification sheets. This specification describes an Elkay product with design, quality, and functional benefits to the user. When making a comparison of other producers' offerings, be certain these features are not overlooked.