

PRODUCT SPECIFICATIONS

Elkay Crosstown® Stainless Steel 25-1/2" x 18-1/2" x 9", Single Bowl Undermount Sink. Sink is manufactured from 18 gauge 304 Stainless Steel with a Polished Satin finish, Rear Right drain placement, and Sound Guard.

Installation Type:	Undermount
Material:	304 Stainless Steel
Finish:	Polished Satin
Gauge:	18
Sound Deadening:	Sound Guard
Number of Bowls:	1
Sink Dimensions:	25-1/2" x 18-1/2" x 9"
Bowl 1 Dimensions:	24" x 17" x 9"
Drain Size:	3-1/2" (89mm)
Drain Location:	Rear Right
Minimum Cabinet Size:	30"
Mounting Hardware:	Part # 54300008 included
Template Included:	Yes
Cutout Template #:	1000001380

Template is available for download at [elkay.com](#)

Installation Profile:

1/8" OVERHANG

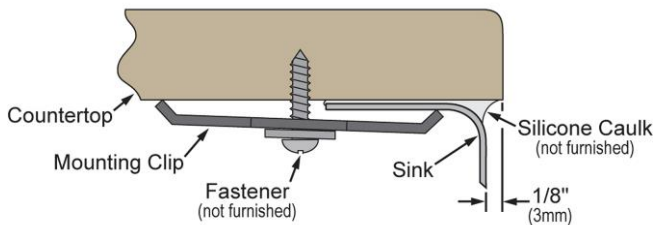

Designed to affix to the underside of any solid surface countertop.

OPTIONAL ACCESSORIES

Bottom Grid:	GFOBG2417RSS
Cutting Board:	LKCBF17HW
Drain:	LKDD, LK35
Faucet:	LK3000CR, LK3001CR, LK5000CR, LK5000LS, LK6000CR, LK6000LS
Sinkmate:	LKSMHSL
Soap Dispenser:	LK320



AMERICAN PRIDE. A LIFETIME TRADITION.
Like your family, the Elkay family has values and traditions that endure. For almost a century, Elkay has been a family-owned and operated company, providing thousands of jobs that support our families and communities.

Product Compliance: ASME A112.19.3/CSA B45.4



Sinks are listed by IAPMO® as meeting the applicable requirements of the Uniform Plumbing Code®, International Plumbing Code®, and National Plumbing Code of Canada.

[Clean and Care Manual \(PDF\)](#)

[Installation Instructions \(PDF\)](#)

[Limited Lifetime Warranty \(PDF\)](#)

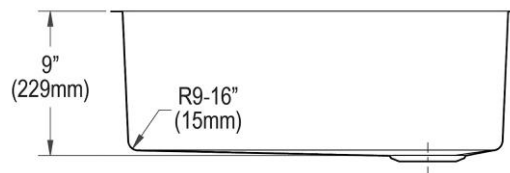
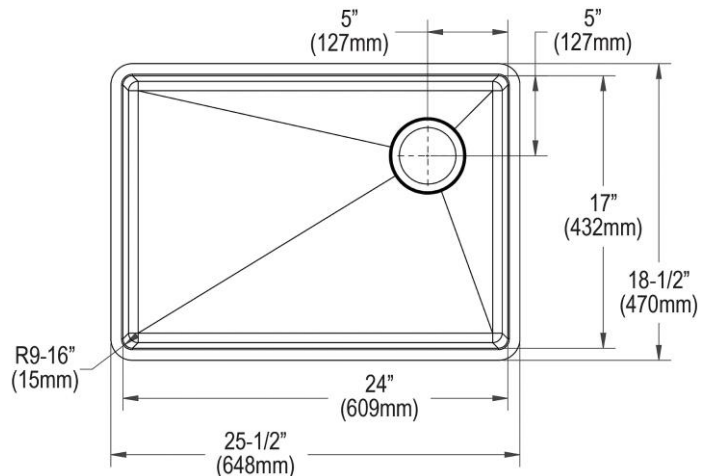

PART: _____ QTY: _____

PROJECT: _____

CONTACT: _____

DATE: _____

NOTES: _____

APPROVAL: _____

In keeping with our policy of continuing product improvement, Elkay reserves the right to change product specifications without notice. Please visit [elkay.com](#) for the most current version of Elkay product specification sheets. This specification describes an Elkay product with design, quality, and functional benefits to the user. When making a comparison of other producers' offerings, be certain these features are not overlooked.