

PRODUCT SPECIFICATIONS

Elkay Crosstown® 18 Gauge Stainless Steel 13-1/2" x 18-1/2" x 9" Single Bowl Undermount Bar Sink & Faucet Kit with Drain. Sink is manufactured from 18 gauge 304 Stainless Steel with a Polished Satin finish, Rear Center drain placement, and Full spray sides and bottom with Sides and Bottom pads.

Installation Type:	Undermount
Material:	304 Stainless Steel
Finish:	Polished Satin
Gauge:	18
Sound Deadening:	Full spray sides and bottom with Sides and Bottom pads
Number of Bowls:	1
Sink Dimensions:	13-1/2" x 18-1/2" x 9"
Bowl 1 Dimensions:	12" x 17" x 9"
Drain Size:	3-1/2" (89mm)
Drain Location:	Rear Center
Minimum Cabinet Size:	18"
Mounting Hardware:	Included
Template Included:	Yes
Cutout Template #:	1000001378

Template is available for download at [elkay.com](#). CAD software will be required to open the template.

Installation Profile:

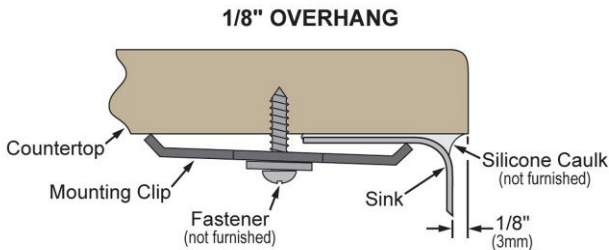

Designed to affix to the underside of any solid surface countertop.



Included with Product:

A Century of Tradition and Quality. For more than 100 years, Elkay has been making innovative products and providing exceptional customer care. We take pride in offering plumbing products that make life easier, inspire change and leave the world a better place.

Product Compliance:

Faucet:

Accessory:

Deep strainer drain LKDD and faucet LKAV3032CR



- ASME A112.19.3/CSA B45.4
- ASME A112.18.1/CSA B125.1
- NSF 61
- NSF 372 (lead free)
- ASME A112.18.2/CSA B125.2

- [Clean and Care Manual \(PDF\)](#)
- [Installation Instructions \(PDF\) - 1000005239](#)
- [Installation Instructions \(PDF\) - 1000005235 drain](#)
- [Warranty \(PDF\)](#)

PART: _____ QTY: _____

PROJECT: _____



CONTACT: _____

DATE: _____



NOTES: _____

APPROVAL: _____

In keeping with our policy of continuing product improvement, Elkay reserves the right to change product specifications without notice. Please visit [elkay.com](#) for the most current version of Elkay product specification sheets. This specification describes an Elkay product with design, quality, and functional benefits to the user. When making a comparison of other producers' offerings, be certain these features are not overlooked.

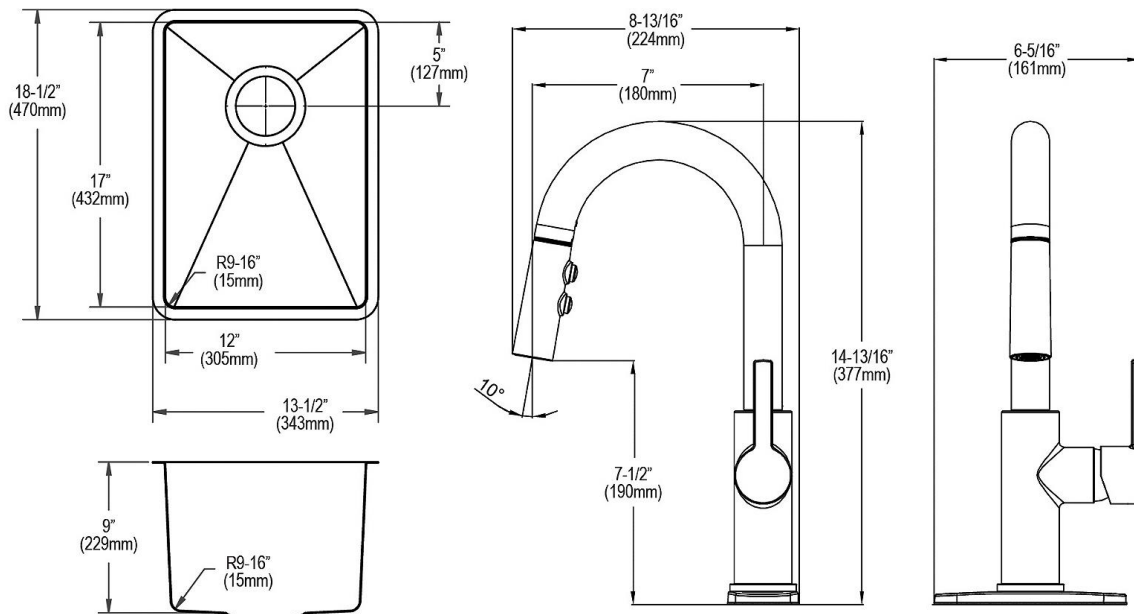
Included Accessories		
ECTRU12179T	Elkay Crosstown 18 Gauge Stainless Steel 13-1/2" x 18-1/2" x 9" Single Bowl Undermount Bar Sink Spec Sheet (PDF)	
LKAV3032CR	Elkay Avado Single Hole Bar Faucet with Pull-down Spray and Lever Handle Chrome Spec Sheet (PDF)	
LKDD	Elkay 3-1/2" Drain Fitting Deep Strainer Basket Spec Sheet (PDF)	



Optional Accessories		
LKDD	Elkay 3-1/2" Drain Fitting Deep Strainer Basket Spec Sheet (PDF)	
LKAV3032	Elkay Avado Single Hole Bar Faucet with Pull-down Spray and Lever Handle Spec Sheet (PDF)	

In keeping with our policy of continuing product improvement, Elkay reserves the right to change product specifications without notice. Please visit elkay.com for the most current version of Elkay product specification sheets. This specification describes an Elkay product with design, quality, and functional benefits to the user. When making a comparison of other producers' offerings, be certain these features are not overlooked.