

SPECIFICATIONS

PRODUCT SPECIFICATIONS

Stainless Steel 22" x 19" x 5-1/2" Wall Hung Lavatory Sink Kit. Sink is manufactured from 18 gauge 304 Stainless Steel with a Buffed Satin finish, Rear Center drain placement, and Bottom only pads.

Material:	304 Stainless Steel
Finish:	Buffed Satin
Gauge:	18
Sound Deadening:	Bottom only pads
Number of Bowls:	1
Sink Dimensions:	22" x 19" x 9"
Bowl 1 Dimensions:	16" x 11-1/2" x 5-1/2"
Drain Size:	1-1/2" (38mm)
Drain Location:	Rear Center





Included with Product: LK723,
LKB736C,
JADA115FS,
JT150

Quality Grade Plumbing Products.
Since 1933 we have become the industry standard for designing and producing quality grade plumbing products and fixtures. Our role as an industry leader remains unsurpassed.



Product Compliance: ASME A112.19.3/CSA B45.4
ADA & ICC A117.1
Faucet: NSF 372 (lead free)
ASME A112.18.1/CSA B125.1
NSF 61

 Sinks and faucets are listed by IAPMO® as meeting the applicable requirements of the Uniform Plumbing Code®, International Plumbing Code®, and National Plumbing Code of Canada.

 Complies with ADA & ICC A117.1 accessibility requirements when installed according to the requirements outlined in these standards.

- [Clean and Care Manual \(PDF\)](#)
- [Installation Instructions \(PDF\) - 2000000893](#)
- [Installation Instructions \(PDF\) - 74180001](#)
- [Warranty \(PDF\)](#)

PART: _____ QTY: _____

PROJECT: _____

CONTACT: _____

DATE: _____

NOTES: _____

APPROVAL: _____

In keeping with our policy of continuing product improvement, Just Mfg reserves the right to change product specifications without notice. Please visit justmfg.com for the most current version of Just Mfg product specification sheets. This specification describes a product with design, quality, and functional benefits to the user. When making a comparison of other producers' offerings, be certain these features are not overlooked.

SPECIFICATIONS

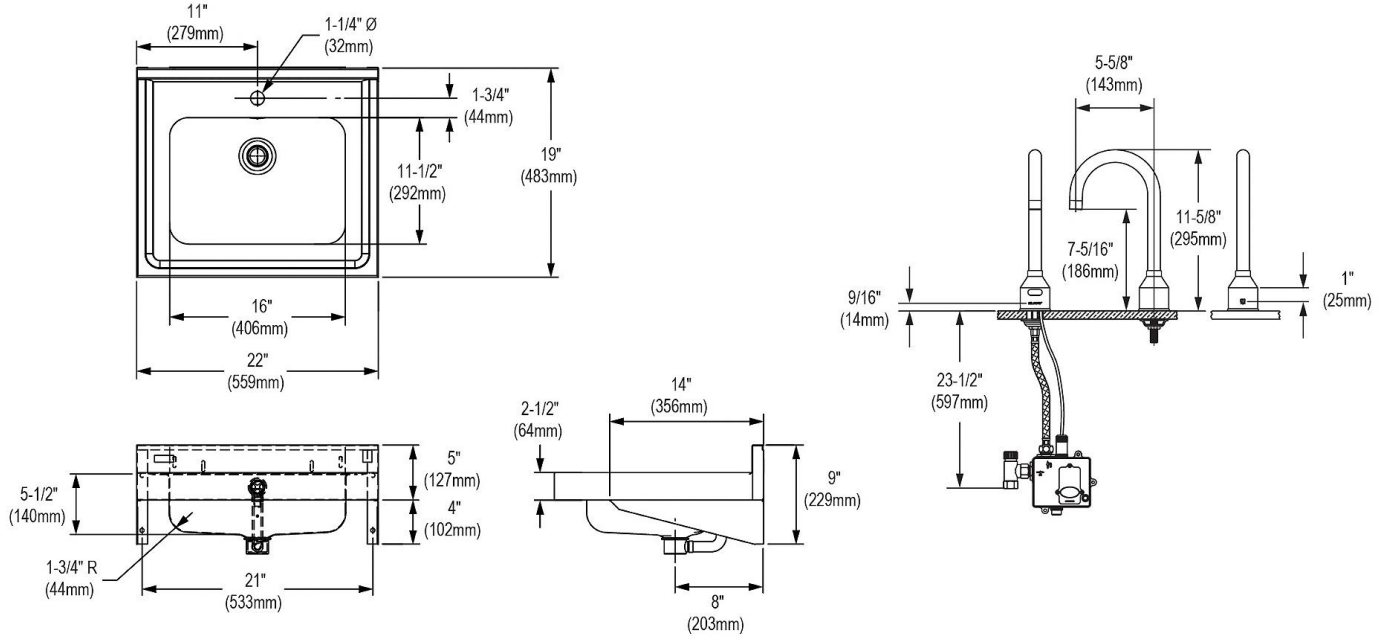

In keeping with our policy of continuing product improvement, Just Mfg reserves the right to change product specifications without notice. Please visit justmfg.com for the most current version of Just Mfg product specification sheets. This specification describes a product with design, quality, and functional benefits to the user. When making a comparison of other producers' offerings, be certain these features are not overlooked.

SPECIFICATIONS

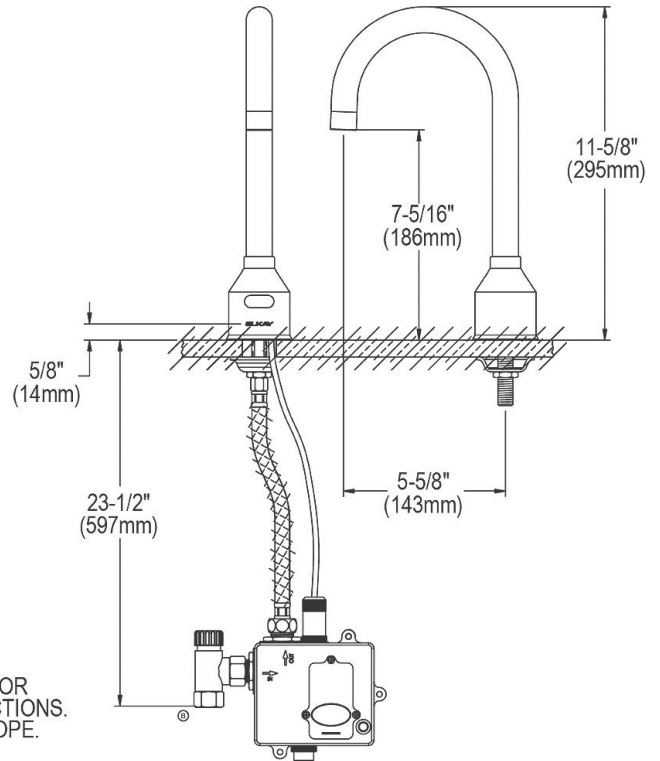
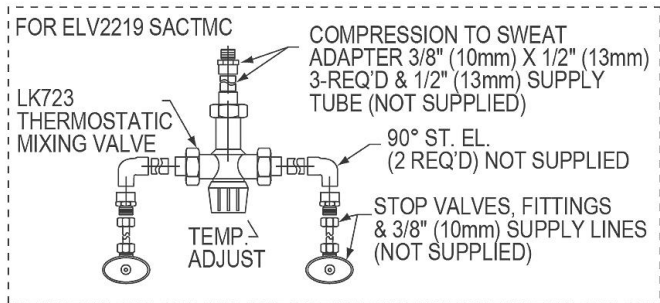
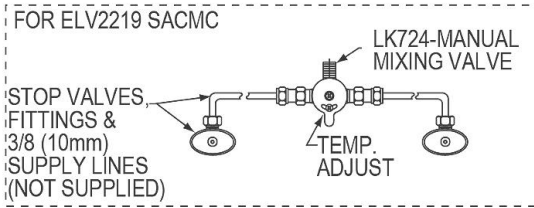
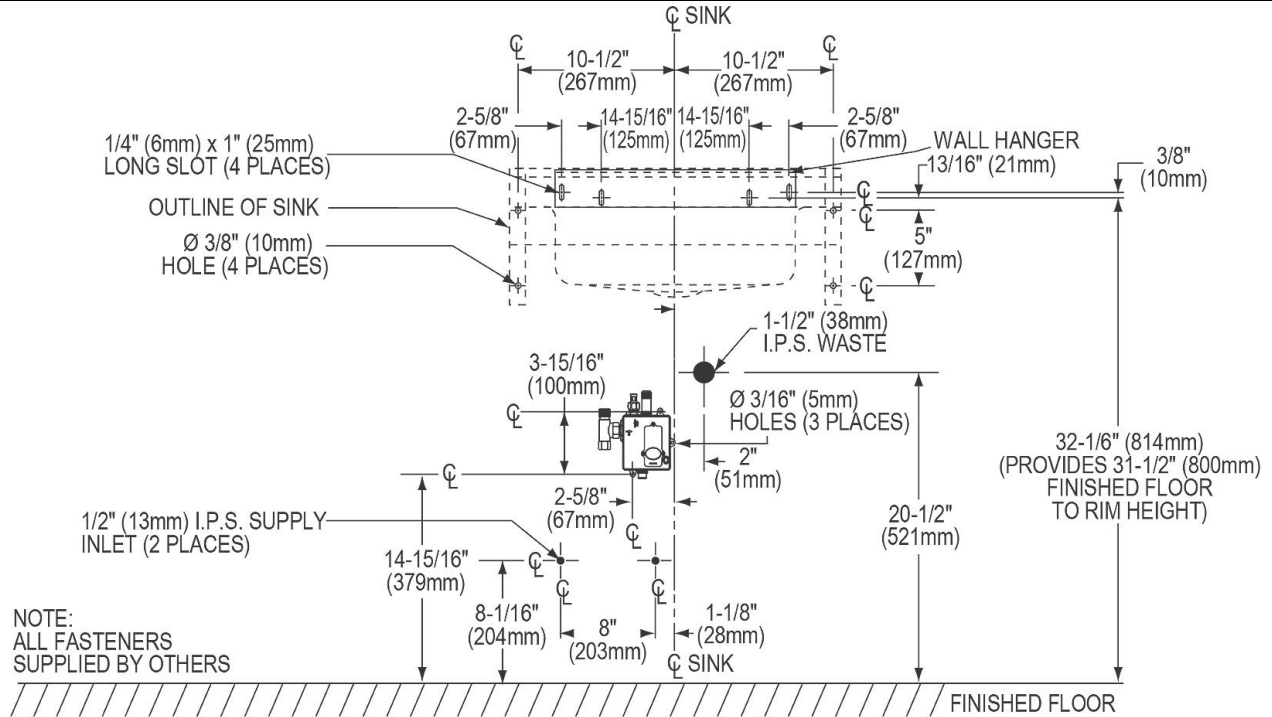

NOTE: USE TEFLON TAPE FOR ALL WATER CONNECTIONS. DO NOT USE PIPE DOPE.

In keeping with our policy of continuing product improvement, Just Mfg reserves the right to change product specifications without notice. Please visit justmfg.com for the most current version of Just Mfg product specification sheets. This specification describes a product with design, quality, and functional benefits to the user. When making a comparison of other producers' offerings, be certain these features are not overlooked.