

PRODUCT SPECIFICATIONS

Elkay Cooler Wall Mount Fully Recessed Non-Filtered Refrigerated 8 GPH, Stainless. Chilling Capacity of 8.0 GPH (gallons per hour) of 50° F drinking water, based on 80° F inlet water and 90° F ambient, per ASHRAE 18 testing. Furnished with Flexi-Guard® Safety Bubbler. Mechanical Front Bubbler Button activation. Product shall be Recessed Mount, for Indoor applications, serving 1 station(s). Unit shall be certified to UL 399 and CAN/CSA C22.2 No. 120. Unit shall be lead-free design which is certified to NSF/ANSI 61 & 372 (lead free) and meets Federal and State low-lead requirements.



| | |
|--|---------------------------------|
| Finish: | Stainless Steel |
| Power: | 115V/60Hz |
| Bubbler Style: | Flexi-Guard® Safety Bubbler |
| Activation by: | Mechanical Front Bubbler Button |
| Mounting Type: | Recessed Mount |
| Chilling Capacity*: | 8.0 GPH |
| Rated Watts: | 325 |
| Dimensions (L x W x H): | 19" x 11-3/4" x 54-1/4" |
| Approx. Shipping Weight: | 114 lbs. |
| Installation Location: | Indoor |
| No. of Stations Served: | 1 |
| *Based on 80° F inlet water & 90° F ambient air temp for 50° F chilled drinking water. | |

- Mechanically-Activated bubbler continues to supply water in event of service disruptions.

COOLING SYSTEM

- Compressor: Hermetically-sealed, reciprocating type, single phase. Sealed-in lifetime lubrication.
- Condenser: Fan cooled, copper tube with aluminum fins. Fan motor is permanently lubricated.
- Cooling Unit: Combination tube-tank type. Continuous copper tubing with is fully insulated with EPS foam that meets UL requirements for self-extinguishing material.
- Refrigerant Control: Refrigerant R-134a is controlled by accurately calibrated capillary tube.
- Temperature Control: Easily accessible enclosed adjustable thermostat is factory preset. Requires no adjustment other than for altitude requirements.

Included with Product: Fully Recessed Fountain, Mounting Box, Chiller

▼ Ships in multiple boxes.

AMERICAN PRIDE. A LIFETIME TRADITION. Like your family, the Elkay family has values and traditions that endure. For almost a century, Elkay has been a family-owned and operated company, providing thousands of jobs that support our families and communities.



PRODUCT COMPLIANCE

ASME A112.19.3/CSA B45.4
Buy American Act
CAN/CSA C22.2 No. 120
NSF/ANSI 61 & 372 (lead free)
UL 399





[Installation Instructions \(PDF\) - 97162C](#)
[Installation Instructions \(PDF\) - 100003083](#)
[Installation Instructions \(PDF\) - 97545C](#)

5 Year Limited Warranty on the refrigeration system of the unit. Electrical components and water system are warranted for 12 months from date of installation. **Warranty pertains to drinking water applications only. Non-drinking water applications are not covered under warranty.**

[Warranty \(PDF\)](#)

PART: _____ QTY: _____
PROJECT: _____
CONTACT: _____
DATE: _____
NOTES: _____
APPROVAL: _____

In keeping with our policy of continuing product improvement, Elkay reserves the right to change product specifications without notice. Please visit elkay.com for the most current version of Elkay product specification sheets. This specification describes an Elkay product with design, quality, and functional benefits to the user. When making a comparison of other producers' offerings, be certain these features are not overlooked.

| Optional Accessories | | |
|------------------------|--|---|
| EWF172 | Elkay WaterSentry VII Filter Kit (Coolers + Fountains) Spec Sheet (PDF) |  |
| 97446C | Accessory - Bubbler Kit Vandal-Resistant Spec Sheet (PDF) |  |

In keeping with our policy of continuing product improvement, Elkay reserves the right to change product specifications without notice. Please visit elkay.com for the most current version of Elkay product specification sheets. This specification describes an Elkay product with design, quality, and functional benefits to the user. When making a comparison of other producers' offerings, be certain these features are not overlooked.

**IMPORTANT!
INSTALLER PLEASE NOTE**

This water cooler has been designed and built to provide water to the user which has not been altered by materials in the cooler waterways. The grounding of electrical equipment such as telephone, computers, etc., to water lines is a common procedure. This grounding may be in the building but may also occur away from the building. This grounding can cause electrical feedback into a water cooler creating an electrolysis which creates a metallic taste or causes an increase in the metal content of the water. The condition is avoidable by installing the cooler using the proper materials as shown below.

NOTICE

The water cooler must be connected to the water supply using a dielectric coupling. The cooler is furnished with a non-metallic strainer which meets this requirement. The drain trap which is provided by the installer should also be plastic to completely isolate the cooler from the building plumbing system.

These products are designed to operate on 20 psi to 105 psi supply line pressure.

OPERATION OF QUICK CONNECT FITTINGS

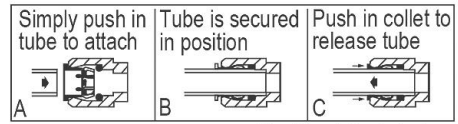

Pushing tube in before pulling it out helps to release tube

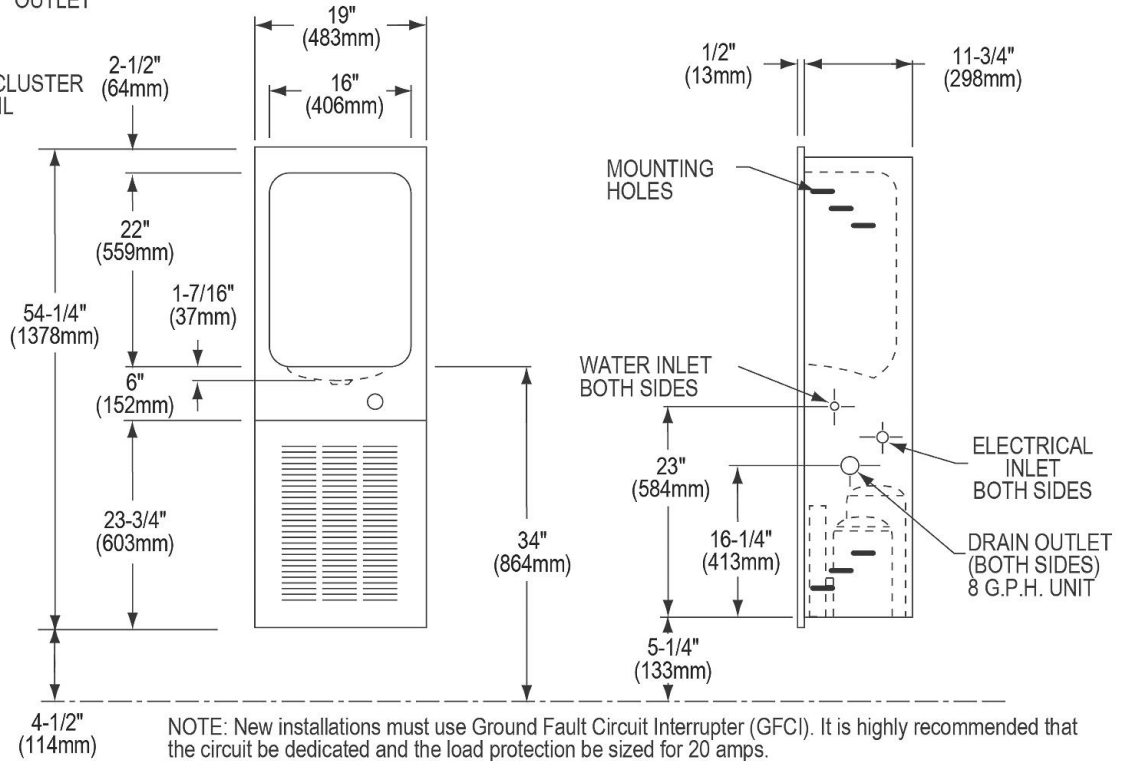
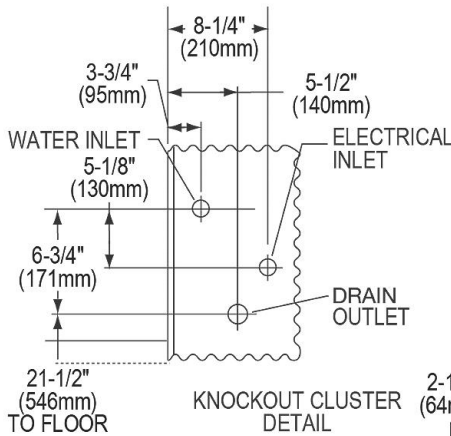
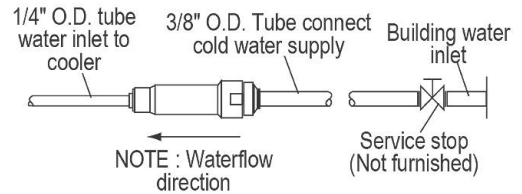

NOTE: New installations must use Ground Fault Circuit Interrupter (GFCI). It is highly recommended that the circuit be dedicated and the load protection be sized for 20 amps.

In keeping with our policy of continuing product improvement, Elkay reserves the right to change product specifications without notice. Please visit elkay.com for the most current version of Elkay product specification sheets. This specification describes an Elkay product with design, quality, and functional benefits to the user. When making a comparison of other producers' offerings, be certain these features are not overlooked.

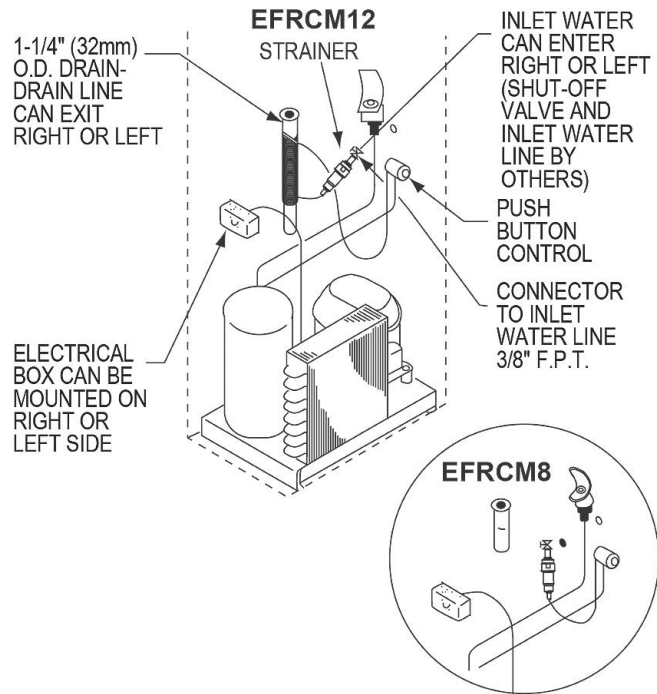
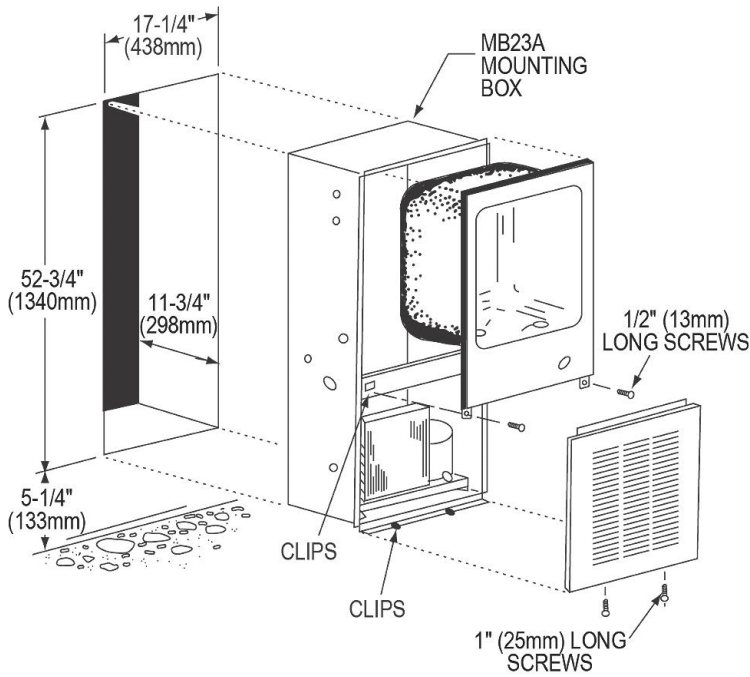

In keeping with our policy of continuing product improvement, Elkay reserves the right to change product specifications without notice. Please visit elkay.com for the most current version of Elkay product specification sheets. This specification describes an Elkay product with design, quality, and functional benefits to the user. When making a comparison of other producers' offerings, be certain these features are not overlooked.